

Operating instructions for ABO shut-off valves series 600 & 900

Obsah

1. General information	1
1.1. Description.....	1
1.2. Labelling on the butterfly valve	1
2. Safety regulations	1
3. Transport and storage	3
4.1. Prerequisites for installation in pipeline.....	3
4.2. Working steps during assembly.....	6
4.3. FLANGE BOLT TENSIONING	6
4.4. Installation errors	7
4.5. Disassembly of flange or pipe behind shut-off valve type T (LUG – eyebolts).....	7
5. Pipeline pressure test	7
6. Operation and maintenance.....	8
7. Troubleshooting.....	8

1. General information

The following sections of this manual provide detailed instructions for the installation, operation and maintenance of the ABO 600 and 900 Series Centrifugal Butterfly Valves. Failure to follow these instructions may jeopardize and void the manufacturer's warranty.

Based on many years of experience in the butterfly valve industry, ABO valve can state that most of the operational problems that occur with ABO 600 and 900 series soft-seal butterfly valves are related to poor installation practices. For this reason, it is very important that distributors educate their customers on the proper installation of resilient seated butterfly valves.

1.1. Description

The ABO 600 and 900 series central butterfly valves are designed to be installed between the flanges of a piping system, to shut off and possibly control the flow of media in the piping. To determine the correct damper type and material design, refer to the catalogue sheets or the manufacturer's recommendations during personal consultation.

The ABO concentric valves of the 600 and 900 series are used for closing or regulation of the flow of media in the pipeline. For selection of the most convenient type of valve and its material design, please refer to the catalogue sheets or the manufacturer's recommendations at a personal consultation.

1.2. Labelling on the butterfly valve

The ABO 600 and 900 series centric butterfly valves have an identification plate on the body which lists the attributes by which the valve can be identified. The type nameplate shall not be obscured so that the installed damper can be identified.

2. Safety regulations

Safety regulations must be carefully read before installation and operation; otherwise, the product warranty is void. All work during installation, operation or the disassembling of the valve must be carried out by professionally trained personnel.

- The valve can only be operated if the parameters of the pressure and temperature of the medium are in accordance with the type data for the given type of valve.
- It must be ensured that the material of the valve components that comes in contact with the transported medium is suitable for that medium.
- An application for which the valve was not intended is not permitted. Please contact our Sales dep. when changing the medium or chemical composition.
- The inner diameter of the flange must be of such dimensions as to prevent damage to the disc during opening. Too small inner diameter of the flange can block the disc and damage it. Too large inner diameter of the flange can affect proper function of the inner seal between the disc and the seat or proper function of the outer seal between the seat and the flanges. For recommended radial clearance between disc and hole in the counterpart, see API 609 Table D.1.
- **ATEX** valve in accordance with ČSN EN ISO 80079-0:2018, ČSN IEC 60079-0:2018. The valves must be conductively connected to the grounded part of the downstream equipment and the measured value of the leakage resistance from the conductive and dissipative parts of the valve must meet the requirements specified in the standard CLC/ TR 60079-32-1:2018, Article 13... $\leq 1 \text{ M}\Omega$.

The real maximum temperature does not depend on the product itself, but on its operating conditions, in particular the temperature of the operating medium. The maximum surface temperature of the shut-off valve in relation to the ignition

temperature of the explosive atmosphere present shall meet the general requirements given in ČSN EN 1127-1:2020, Article 6.4.2. To determine the maximum surface temperature of the product T in relation to its operating temperature T_{op} , the following applies: $T_{op} \leq +40\text{ °C}$: $T = 40\text{ °C}$; $+40\text{ °C} < T_{op} \leq +200\text{ °C}$: $T = T_{op}$. To determine the maximum surface temperature T of a product in relation to its marked temperature class, the following applies: T6 ... $T \leq +68\text{ °C}$; T5 ... $T \leq +80\text{ °C}$; T4 ... $T \leq +108\text{ °C}$; T3 ... $T \leq +160\text{ °C}$. The relative humidity of the medium must be $\leq 40\%$ for the FPM-002 in ATEX version. The 900 series butterfly valves themselves are certified as FTZÚ 14 Ex 0004. The certification does not apply to any electrical or pneumatic

under pressure. If it is necessary to install a valve without an actuator, it is necessary to ensure that the valve will not be under pressure equipment used to operate the valve. The ambient temperature range T_a for a butterfly valve equipped with a particular type of sealing collar is specified in the manufacturer's documentation supplied with the product.

- If the valve is used as an end fitting, there must be a blanking flange on the free outlet of the valve or the valve must be securely fixed in the closed position (locking the lever, etc.).
- If it is necessary to open the valve installed at the end of pipeline, care must be taken with the escaping medium to prevent possible damage or injury.
- The valve in the design for oxygen and "silicon free" must be packed in the original plastic packaging from the manufacturer until the final installation in the pipeline. When mounting, use clean tools (free of grease, dust, chips, etc.) and work clothes to avoid contamination of the valves.
- The valve with actuator must be adjusted before installation in the pipeline, with emphasis on the adjustment of the end positions.
- Actuated valves for regulation must be designed so that cavitation does not occur (consult the manufacturer if necessary).
- Check the function of the valve with actuator in detail only after installation between the pipe flanges.
- Before removing the valve from the piping, the piping in front of and behind the valve must be depressurized - risk of uncontrolled leakage of liquid. If the fluids are harmful to health, the pipes must be completely emptied. The valve must be decontaminated.
- During transport and storage of valves without levers or without actuator it must be ensured that the valve is not open (risk of damaging the disc).
- The position of the lever shows the position of the disc. The lever is perpendicular to the pipe - the valve is closed; the lever is parallel to the pipe - the valve is open.
- The valves are not self-locking; therefore, the lever or actuator must not be removed when the piping is under pressure.
- Opening and closing the valve must not be abrupt, but smooth, to avoid hydraulic shock and damage to the pipeline and possible danger to persons.
- The piping connection must be made in such a way that no stress or vibration is transmitted to the valve during and after installation.
- The valves are mounted in a pipeline with a steady flow. It is necessary to take into account general rules for stabilizing the flow behind a pipe element causing turbulences (e.g. pump, other valves, etc.). Normally min. 6xDN against the direction and min. 4xDN in direction of flow, but it depends on the conditions specified by the designer.

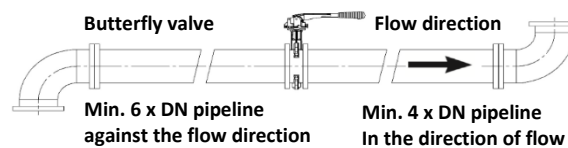

Fig. 1: Valve in pipeline

- When the medium temperature or ambient temperature is higher or lower than that recommended by the actuator manufacturer, it is necessary to isolate (protect) the actuator from these temperatures according to actuator manufacturer's instruction.
- For single-acting pneumatic actuators in the NO (normally open) design, the sealing edges of the disc must be protected during transport and storage. When installing the valve must be manually closed or closed by the pneumatic actuator.
- Pneumatic (or hydraulic) actuators must be adjusted so that the valve is not opened or closed rapidly. Unless otherwise stated, a closing time of $t \text{ (sec)} = \text{DN (mm)}/50$ is recommended. Double-acting pneumatic actuators are not self-locking, so they must always be under air pressure.
- The electric actuator must be adjusted so that the actuator is switched off by the limit switch, not by the torque switch (see the instructions of the electric actuator manufacturer).
- For valves DN 300 and larger, a horizontal shaft position is recommended. For DN 32-250 valves, any position is permitted (unless there is a restriction from the actuator manufacturer).
- Control of a valve-mounted actuator is only permitted if the valve is connected to the piping on both sides. If operated before meeting this condition, there is a risk of injury, and the user is solely responsible for it. An exception is the valve with an actuator, where the disc is open (NO) in the basic position. Here it is essential to throttle down the disc before assembly by the means of hydraulic system or controls.
- The valves should be manually controlled without extra effort. It is not allowed to strike the valve or use any extensions to enlarge the leverage.
- Lift the valve with ties stretched through ears, eyebolts bolted into the body of the T design or the valve neck. Never lift with ties pulling the actuator or stretched through the inner opening of the valve for the disc.

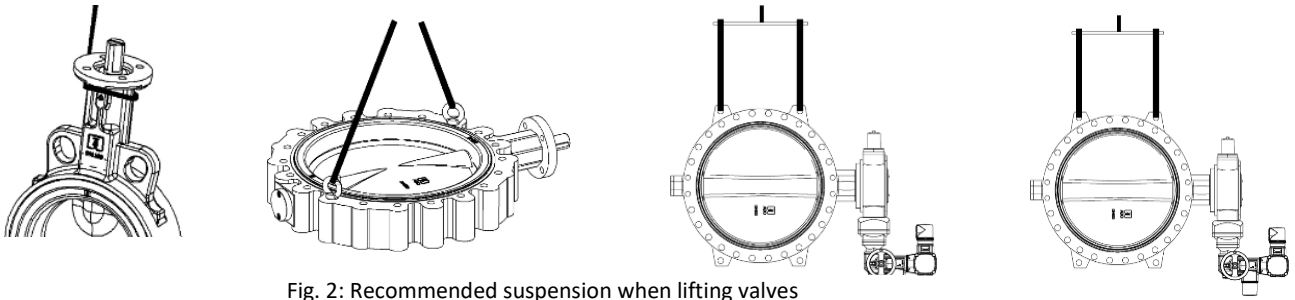

Fig. 2: Recommended suspension when lifting valves

- Never step on valves or actuators.
- Never mount the valves directly on rubber expansion joints due to the increased torque and the valve being practically inoperable.
- After removing the valves from the piping, take care not to damage the sealing surfaces and the seat.
- Do not use the valve as a support in the construction of pipelines.
- It is not allowed to use spare parts from other manufacturers. Safe operation cannot be guaranteed.
- In the event of malfunctions or damage to the valve, contact the sales dep. or reklamace@abovalve.com.

3. Transport and storage

Basic guidelines for the storage of parts containing elastomers are given in ISO 2230.

Principles of proper storage:

- Valves should be stored in closed, dry, dust free and air-conditioned room at temperatures between +5°C to +25°C. Ideally around 15°C. At temperatures below 10°C, the seat may partially stiffen. Seats should not be exposed to direct sunlight, ozone, contact with solvents, direct contact with heating elements, mechanical damage, vibrations or deformations. We do not recommend storing the valves on the floor. During long-term storage of rubber, its elasticity decreases. Relative humidity should not exceed 50%. Leave the valve in the original packaging from the factory until the beginning of assembly. When storing for more than 5 months, all surfaces that come in contact with the seat must be thoroughly cleaned and lubricated with silicone grease.
- Valves should be stored with a disc in a slightly open position (about 15°, never fully closed!!). The edges of the disc should be protected from mechanical damage.
- Valves should not be stacked as the seat could be damaged. If stacked, it is necessary to use cardboard or mirelon spacers.
- During long-term storage, it is necessary to rotate the disc regularly to prevent the moving parts of the valve from stiffening. If it gets stiffen, the disc and the seat must be carefully cleaned and then preserved with silicone grease. Then open and close the valve several times. Never rotate the disc when stored at a temperature lower than 0°C.
- Protective coatings and preservatives layers must be checked at six-month intervals and repair if needed. Preserve the seat with silicone grease.

Principles of good transport:

- When transporting larger valves by crane, it is necessary to tie only the body, not actuator or lever (Fig. 1).
- Valves delivered without actuator must be transported in such a way that they cannot open in their transport position due to external impacts (shocks).

4. Installation in the pipeline

Installation of dampers into the piping system may only be carried out by specialist personnel who, on the basis of their qualifications, expertise and experience, are able to correctly assess and carry out the work required and identify and eliminate any risks.

4.1. Prerequisites for installation in pipeline

- The sealing surfaces of the valve are formed by a part of a rubber seat. We recommend using B-shape pipe flanges with smooth surface according to EN 1092-1.
- Shut-off valves are mounted between neck or flat flanges according to EN1092-1.
- Prior to installation, it is necessary to check whether the supplied valve corresponds to PN, DN and materials for the given use and whether there was no damage to the valve during transport (damaged valve must not be used!).
- Before mounting the valve, thoroughly clean the piping system from mechanical dirt, scale, rust, slag, etc. There must be no sharp edges on the parts that would damage the seat. Lubricate rubber parts that do not have enough grease on the seats with silicone grease.
- If the valves were stored at temperatures lower than 0°C, they must be kept in an environment where the temperature is at least 10°C for 24 hours prior to installation. The valves are thus heated in the entire cross section. Only then can they be mounted in the pipeline.

- When installing the valve, the piping must not be under pressure.
- If necessary, support the valve during installation (during installation only) to prevent unnecessary stress caused by connecting the pipes.
- The customer decides on the pipe fitting according to the overall solution of the pipe system.
- Adjust both pipe flanges so that the valve can be inserted between them without damaging the seat. No sharp tools may be used for assembly.
- The pipe flanges must be parallel and the axes of both pipes must be coaxial. Non-parallel flange adjustment leads to leakage valves in the seat because the pressure on the seat will be uneven. Flange parallelism tolerance according to **EN558**. **The check of the inner diameter of pipe flanges is very important for a reliable valve function.**

Tab. 1: Tolerances of parallelism

DN	Tolerance[mm]
32-150	0,6
200-300	0,8
350-500	1,0
600-800	2,0

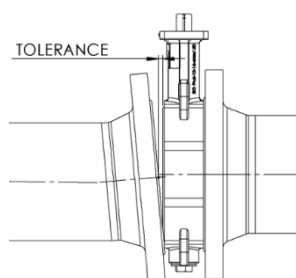

Fig. 3: Parallelism of flanges

- Check the inside diameter of the companion flanges for correct function of the valve (rotation of the disc). For information on the size of the disc outlet from the valve, see Tab. 2. Possible misalignment of the pipe flanges, disc clearance, imperfect centring of the valve and the shape of the seat must be taken into account!!! **Too small inner diameter of the pipe flange** leads to obstruction of the and can cause serious disc damage and valve malfunction. **Too large inner diameter of the pipe flange** can disable proper function of the inner seal between the disc and the seat, or proper function of the isolation between the seat and the pipe flange.

Tab. 2: Dimension of the disc overlap from the valve and inner diameter of the flange

DN		Overlap of the disc from the valve Z, mm	Construction length E, mm	Inner diameter of neck flange EN1092-1 type 11 on pipe PN6,10,16, Cl. 150 (GOST PN16), mm	Min. inner diameter of the pipe flange, mm
32	1 1/4 "	22	33 B, T	32.8 -37.2 (31)	31
40	1 1/2 "	22	33 B, T	39.3-43.1 (38)	31
50	2 "	24	43 B, T / 111 F	51.2-54.5 (49)	34
65	2 1/2 "	45	46 B, T / 115 F	70.3 (66) 62.7 Cl. 150	54
80	3 "	65	46 B, T / 117 F	82.5 (78)	72
100	4 "	85	52 B, T / 130 F	100.8-107.1 (96)	90
125	5 "	111	56 B, T / 143 F	125-131.7 (121)	119
150	6 "	137	56 B, T / 143 F	150-159.3 (146)	146
200	8 "	190	60 B, T / 155 F	207.3-206.5 (202)	196
250	10 "	239	68 B, T / 168 F	254-260.4 (254)	249
300	12 "	289	78 B, T / 182 F	309.7 (303)	297
350	14 "	327	78 B, T / 194 F	339.6-352 (351)	335
400	16 "	363	102 B, T	390.4-403 (398)	370
450	18 "	425	114 B, T / 227 F	441 (442,8)	433
500	20 "	474	127 B, T / 234 F	492 (501)	484
600	24 "	559	154 B, T / 272 F	590-595.8 (602)	566

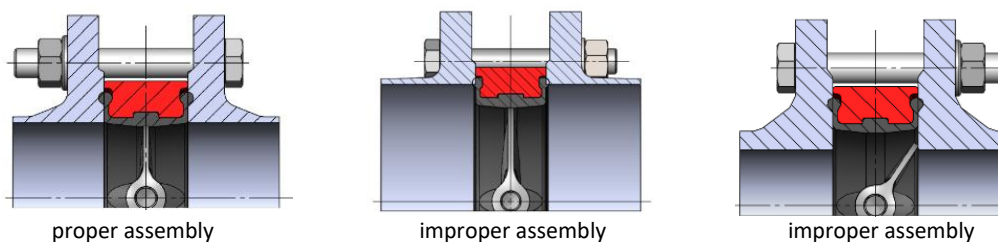
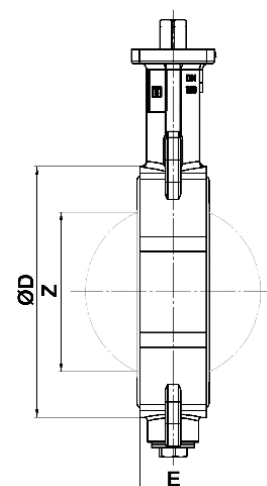
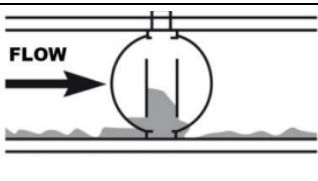
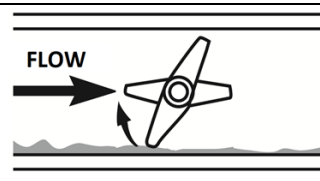
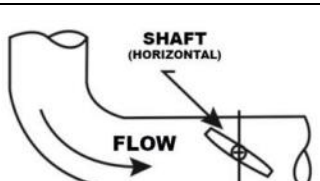
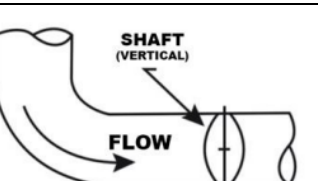
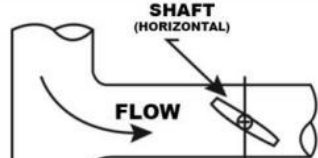
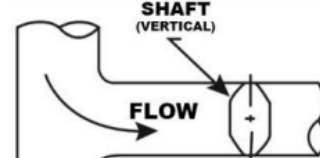
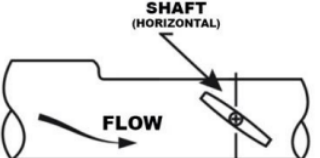
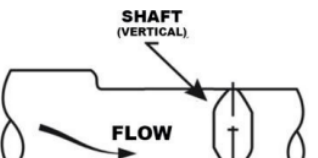
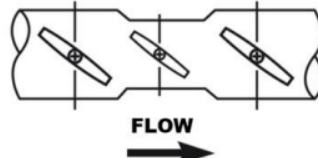
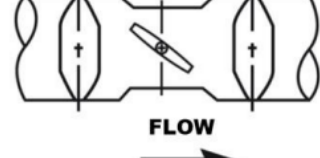
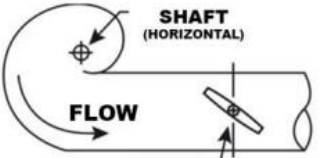
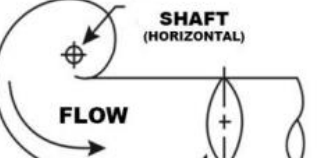
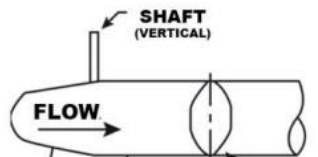
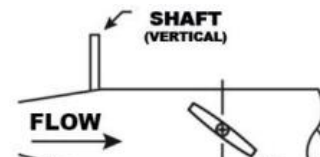
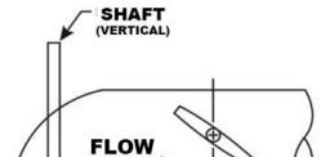
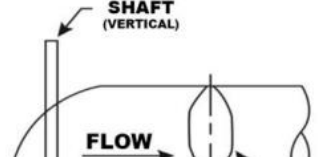

Fig. 4: Mounting between flanges

- It is generally recommended that the damper be installed in the piping system in a vertical position. However, there are applications where the damper is installed horizontally (Tab. 3).

Tab. 3: Valve orientation

<i>Improper installation</i>	<i>Proper installation</i>	<i>Improper installation</i>	<i>Proper installation</i>
Abrasive cloths		Knee	
 <p>Shaft vertical, sludge accumulates on the disc</p>	 <p>Shaft horizontal, sludge passes under the disc</p>	 <p>Valve shaft (horizontal)</p>	 <p>Valve shaft (vertical)</p>
T- piece		Pipe reduction	
 <p>Valve shaft (horizontal)</p>	 <p>Valve shaft (vertical)</p>	 <p>Valve shaft (horizontal)</p>	 <p>Valve shaft (vertical)</p>
Valve orientation		Centrifugal pump – o shaft orientation	
 <p>Increased noise, erosion and vibration</p>	 <p>Reduced noise, erosion and vibration</p>	 <p>Horizontal pump shaft and horizontal valve shaft</p>	 <p>Horizontal pump shaft and vertical valve shaft</p>
The spun-pump shaft of the pump vertical and horizontal		Axial pump-vertical pump shaft and vertical valve shaft	
 <p>Vertical pump shaft and vertical valve shaft</p>	 <p>Vertical pump shaft and horizontal valve shaft</p>	 <p>Vertical pump shaft and horizontal valve shaft</p>	 <p>Vertical pump shaft and vertical valve shaft</p>

4.2. Working steps during assembly

- Insert the flap with a slightly open butterfly (approx. 15°) between the flanges (the butterfly must not exceed the construction length of the flap). Then lightly tighten and centre the flap with the 2 upper and 2 lower screws. **Do not use any additional gaskets between the pipe flanges and the butterfly valve. For dampers with thicker coating thicknesses (C4, C5) take extra care when installing the damper and tightening the screws to avoid cracking the coating.**
- Open the valve passage and verify that the disc is easily movable (does not touch the counterpart).
- Spot weld the flanges at several places to the pipe.
- Then remove the valve and weld the flanges around the entire circumference to the pipe. After the flanges have cooled down, re-insert the valve between the pipe flanges (with sufficient clearance), align and lightly tighten the 4 bolts. Open the valve passage and verify that the disc is easily movable throughout its range of motion.
- Add the other bolts and tighten them crosswise.
- Tighten the bolts so that the companion flange only lightly touches the metal of the valve body. In this way, an optimal and sufficient seal is achieved. This condition needs to be checked visually.
- Uneven tightening of the bolts results in increased valve torques.
- Check the proper function of the valve (the disc must not hit the pipe flanges).
- Due to the fact that the pipes may suffer from prestressing, misalignment or non-parallelism of flanges, or expansion of flanges is greater than the construction length, proper tightening of the valve in the flange joint cannot be guaranteed by checking the tightening torque.
- Valves with eyebolts allow mounting on the pipe end, but these valves can be regularly used as the terminal valves only when the pressure before the valve is less than 6 bar for DN32- 200 and 3 bars for DN250 and larger. The reason is that the seat is not clamped sufficiently evenly between the two flanges. The valve with eyebolts with through holes or threads can be used at the pipe end with full pressure only if they are reinforced by the companion flange or have a lever with a locking device in the closed position.

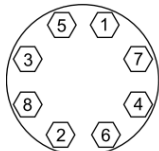

Fig. 5: Cross tightening

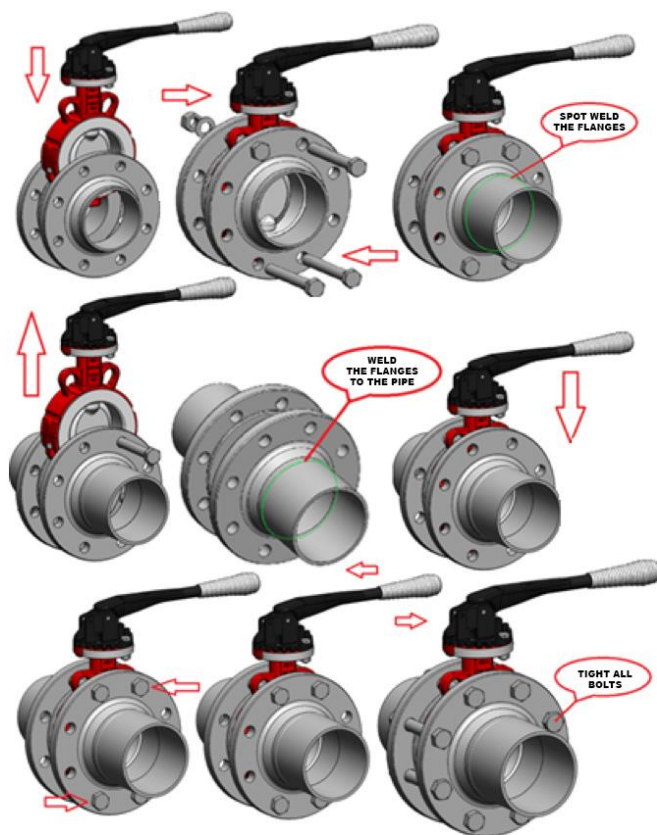

Fig. 6: Installing the valve between the flanges using screws

4.3. Flange bolt tensioning

When installing centric butterfly valves in a piping system, there are several factors that affect the tightening torques. Below is a list of information that affects tightening torques.

Valve	Type / Size / Material	Lubrication	Applications / Type
Flange	Type / Size / Surface finishes	Torque wrench	Usage/ Accuracy
Bolt/ Stud	Type / Material / Surface conditions	General factors	Temperature / Screw tightening speed / Method of tightening (cross-tightening to evenly distribute the tension on the connections)

- Complete knowledge of all relevant conditions is almost impossible to obtain, so no reputable manufacturer can provide completely accurate tightening torque information.
- The procedure for installing the damper into the piping system using the tightening torques in is described in Section 4.2.
- ABO valve issues this recommendation only as a guide to installation. This recommendation is based on full compliance of all materials supplied with their respective specifications. As many components are not manufactured by ABO valve, we cannot be held responsible for any damage caused during installation.
- Tightening must be carried out sequentially always to the cross with gradual tightening to 15 % / 40 % / 100 % of the specified M_k in

- Tightening torque values are based on the use of new, lubricated fasteners. When using unlubricated fasteners, 20% may be added to the recommended tightening torque values. The increase in torque from is only possible in the event of a leak at the flange joint and only after approval by the manufacturer after checking all the above factors.
- When installing valves in pipes, washers must be inserted under the bolt heads and nuts to distribute the pressure in the joint and also to reduce friction under the nut and bolt head during tightening.
- For type B (wafer) valves, where no bolts/threaded rods are screwed into the body, the recommended bolt tightening torques can be increased, if necessary, up to the maximum values specified by the manufacturer of the chosen fastener.
- For type T (lug)/B (wafer) valves where there are blind threaded holes in the body, only threaded rods may be used when installing the valve in the pipe and tightened with a washer and nut to the recommended tightening torque from Table 4. The threaded rod must be screwed to the stop in the blind thread.
- For T (lug) type valves with through threaded holes, the bolts/threaded rods must be screwed into the body to a minimum depth of $0.75xD$, where D is the nominal diameter of the bolt/threaded rod. In installations where bolts are used, it must be ensured that the bolts do not touch each other in the body, otherwise the inter-flange connection cannot be tightened.
- The tightening torques in are valid only for ABO S600 and S900 soft-sealing dampers where the sleeve acts as an inter-flange seal. They are not valid for other types of butterfly valves.

Tab. 4: Recommended bolt tightening torques M_k [Nm]

Screw	M_k [Nm]	Screw	M_k [Nm]
M12	20-30	M30	170-220
M14	1/2"-13 UNC	M33	190-340
M16	5/8"-11 UNC	M36	220-460
M20	3/4"-10 UNC	M39	250-550
M24	7/8"-9 UNC	M45	450-800
M27	1"-8 UNC	M52	950-1300

4.4. Installation errors

- Insufficient parallelism of the flanges - the pressure on the seat will be uneven on both sides, there will be a deformation of the seat and thus a leak between the valve and the flange, or between the seat and the shaft.
- The flanges are too close to each other - the seat can be deformed during assembly and thus wear out quickly. On the contrary, with a large flange distance, there is a large tension in the pipe during tightening.
- Deformation of the seat caused by mounting the valve with the disc in the closed position - permanent deformation of the contact surfaces of the seat and the disc may occur. This increases the valve torque.
- Use of incorrect flanges - the disc may collide with the inner hole of the flange (if the inner diameter is too small), which will prevent the disc from opening properly and cause damage.
- Use of an additional seal between the valve and the pipe flange - the seat will be pushed inwards, which will increase the torque of the valve and make the disc opening improper or impossible.
- Welding near the shut-off valve - the seat is damaged due to high temperature.
- Mounting the valve directly on the rubber expansion joint - the torque is increased by the action of the rubber expansion joint and the valve is practically impossible to control.

4.5. Disassembly of flange or pipe behind shut-off valve type T (LUG – eyebolts)

The same safety rules apply as for installation.

- Close the pressure supply so that there is no overpressure or shock when removing the flange or pipe.
- The disc must be in the closed position.
- Check that the pressure in front of the valve does not exceed 6 bar for valves DN32 - 200 and 3 bar for valves DN 250 and larger. The figures below show LUG valves (with eyebolts) which are mounted between the pipe flanges.
- Gradually loosen the bolts crosswise on the side behind the valve, and then remove the flange and piping behind the valve.

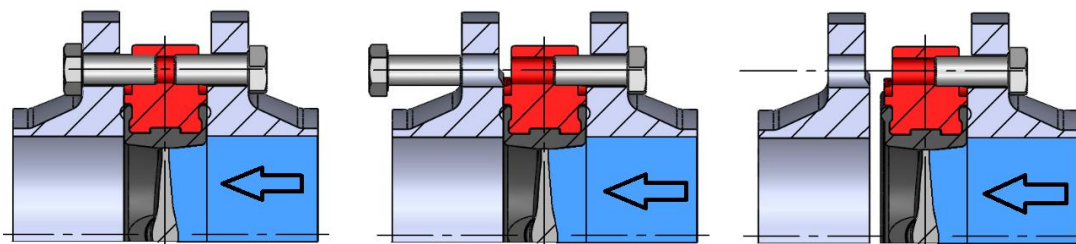

Figure 7: Removing the flange behind the valve

5. Pipeline pressure test

The valve itself is depressurized by the manufacturer. After installation in the pipeline, it is necessary to pressurize the entire pipeline section with valves. In doing so, the following must be observed:

- The newly installed segment must be thoroughly flushed (cleaned) before mounting valves and all mechanical impurities removed.
- The test pressure with open valves is 1.5 times PS.
- The test pressure with closed valves is 1.1 times PS.

6. Operation and maintenance

- Normal force is enough for manual control of the valve; it is not suitable to extend the length of the lever.
- When the lever is parallel to the pipe, the valve is open, the position of the lever perpendicular to the pipe means that the valve is closed.
- Valves with a lever or worm gear are closed in a clockwise direction and opened in a counter clockwise direction.
- Valves with electric or pneumatic actuator are controlled by signals and are set by the manufacturer. This setting should not be changed without the consent of the manufacturer.
- Opening and closing must be gradual rather than abrupt, to avoid water hammer.
- The valves are maintenance-free, during operation only the leakage from the outer surface should be checked.
- If there are problems with the tightness of the seat or shaft, the seat or O-rings can be replaced with new ones.
- If the valve remains in the same position for a long time, it is advisable to close and open the valve at least four times a year.
- Permitted flow velocities are 4 m/s for liquids and 30 m/s for gases. The flow rate is determined according to the type of use of the valve (suction/displacement), the location of use, the inner diameter and length of the pipe, the working pressure, the temperature of the medium, the material of the pipe, etc.
- In the case of ATEX design of the damper, the functionality of the ATEX screw spring must be checked once a year. In case of non-functionality, the screw must be replaced with a new one.

7. Troubleshooting

Symptom	Possible cause	Solution
Leakage between valve and pipe flanges	Flange bolts are not tightened	Tighten the bolts
	The valve is not centred	Reinstall the valve into proper position
	Large inner flange diameter	Flange replacement
	Burnt or damaged seat	Seat replacement
	The flanges are not parallel	Total repair necessary
	The flanges are damaged by welding or are not completely straight	Total repair necessary
The valve cannot be closed or opened	Solid particles between the seat and the disc	Remove the valve and clean it, or replace damaged parts
	Hardened or porous seat	Seat replacement
	The medium pressure is higher	Check the medium pressure
	Actuator is blocked	Actuator control
	The electric actuator is not connected to the mains	Connect the actuator to the mains
The valve in the closed state is leaking	Incorrect close position	Check position adjustment
	Worn disc	Disc replacement
	Worn seat	Seat replacement
Leakage around the shaft	Damaged seat or shaft seals	Seat or seal replacement
	The flanges are not parallel, i.e. uneven deformation of the seat	Total repair necessary
	Improper actuator, actuator not installed properly, i.e. excessive pressure on the shaft	Actuator replacement, correct assembly
Bursting function	Dirt caught in the valve	Open and close the valve several times and flush it
	Insufficient air supply to the actuator	Increase pressure or volume of the supplied air
The valve does not rotate	Actuator failure	Replacement or repairs of the actuator
	The valve is clogged with dirt	Flush or clean the valve
Movement of the seat in the body of the valve	Media speed too high (seat is sucked away from the body)	Attach the seat with special glue or use a valve with vulcanized seat
	Companion flanges have too large inner diameter	Total repair necessary
	The disc remained in the closed position for a long time and the seat dried up	Disc must rotate regularly
The disc cannot be fully opened and closed	Incorrect inner diameter of the flange – <u>compaction of the seat inwardly</u>	Total repair necessary
	Improper mounting of the seat in the body - medium leaks between the seat and the body	Proper assembly of the seat
Increased torque and torque on the valve	Dirt on the seat	Clean the seat
	Valve tightened too much between the pipe flanges	Tighten the bolts with lower torque
	Improper installation of the valve in the pipeline	Check the installation of the valve in the pipe
	The actuator is not fastened properly	Tighten the bolts that fasten the actuator
The valve is noisy	Improper mounting position	Change the mounting position
	The valve works outside the designed parameters	Check the project conditions vs the operation conditions

**Pipe bolt lengths
with neck welded
flanges according to EN1092-1.**
Bolt lengths apply for use
with washers under nuts and
under bolt heads.

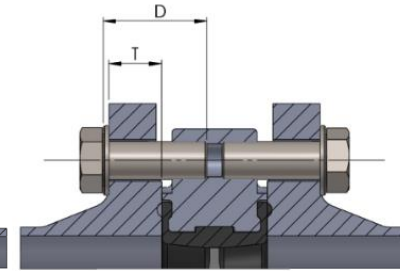
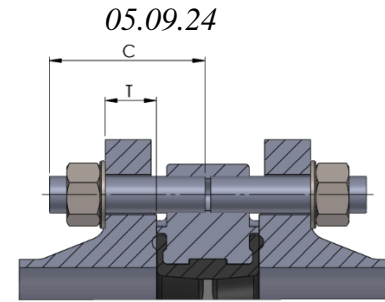
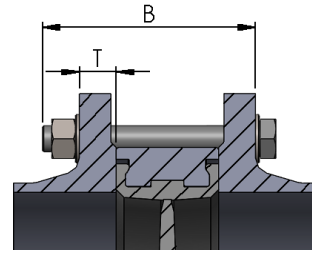
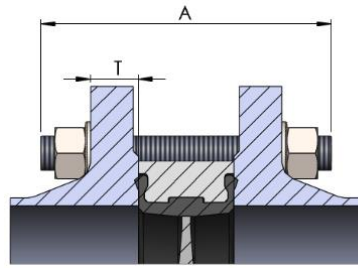

Size		PN6								PN10							
DN	NPS	Bolt size	Number of bolts, thread. rods A, B	A Threaded rod Nut Washers	B Bolt Nut Washer	Number of bolts, thread. rods C, D	C Threaded rod Nut Washer	D Bolt Washer	T	Bolt size	Number of bolts, thread. rods A, B	A Threaded rod Nut Washers	B Bolt Nut Washer	Number of bolts, thread. rods C, D	C Threaded rod Nut Washer	D Bolt Washer	T
32	1 1/4	M12	4	100	80	8	50	30	14	M16	4	115	9 5	8	55	35	18
40	1 1/2	M12	4	100	80	8	50	30	14	M16	4	115	9 5	8	55	35	18
50	2	M12	4	110	90	8	55	35	14	M16	4	125	10 5	8	60	40	18
65	2 1/2	M12	4	110	100	8	55	35	14	M16	4	130	110	8	60	40	18
80	3	M16	4	120	100	8	60	40	16	M16	8	130	110	16	60	45	20
100	4	M16	4	130	110	8	60	40	16	M16	8	140	120	16	65	45	20
125	5	M16	8	140	120	16	65	45	18	M16	8	150	120	16	70	50	22
150	6	M16	8	140	120	16	65	45	18	M20	8	150	130	16	75	50	22
200	8	M16	8	150	130	16	70	50	20	M20	8	160	140	16	80	55	24
250	10	M16	12	160	140	24	75	55	22	M20	12	170	150	24	85	60	26
300	12	M20	12	170	150	24	80	60	22	M20	12	180	160	24	85	65	26
350	14	M20	12	170	150	24	80	60	22	M20	16	190	190	32	85	65	26
400	16	M20	16	200	180	32	90	65	22	M24	16	220	220	32	100	75	26
450	18	M20	16	210	190	32	100	75	22	M24	20	230	205	40	100	80	28
500	20	M20	20	230	210	40	-	-	24	M24	20	250	250	40	100	70	28
600	24	M24	20	270	250	40	-	-	30	M27	20	280	270 "U"	40	110	80	30
700	28	M24	20	290 "U"	260 "U"				30	M27	20 "U"	300 "U"					35
700	28	M24				8 "U"	80 "U"	50 "U"	30	M27			310 "U"	8 "U"	85 "U"	55 "U"	35
800	32	M27	20 "U"	320 "U"	285 "U"				30	M30	20 "U"	340 "U"					38
800	32	M27				8 "U"	80 "U"	50 "U"	30	M30			320 "U"	8 "U"	95 "U"	60 "U"	38
900	36	M27	24 "U"	340 "U"	305 "U"				34	M30	20 "U"	350 "U"					38
900	36	M27				8 "U"	85 "U"	55 "U"	34	M30			350 "U"	8 "U"	95 "U"	60 "U"	38
1000	40	M27	24 "U"	360 "U"	330 "U"				38	M33	24 "U"	380 "U"					44
1000	40	M27				8 "U"	90 "U"	60 "U"	38	M33			410 "U"	8 "U"	105 "U"	70 "U"	44
1200	48	M30	28 "U"	410 "U"	375 "U"				42	M36	28 "U"	450 "U"					55
1200	48	M30				8 "U"	100 "U"	65 "U"	42	M36			460 "U"	8 "U"	120 "U"	80 "U"	55
1400	56	M33	32 "U"	470 "U"	430 "U"				56	M39	32 "U"	500 "U"					65
1400	56	M33				8 "U"	115 "U"	80 "U"	56	M39			520 "U"	8 "U"	130 "U"	90 "U"	65
1600	64	M33	36 "U"	525 "U"	485 "U"				63	M45	36 "U"	570 "U"					75
1600	64	M33				8 "U"	125 "U"	90 "U"	63	M45				8 "U"	150 "U"	105 "U"	75

Size		PN16								CLASS 150							
DN	NPS	Bolt size	Number of bolts, thread. rods A, B	A Threaded rod Nut Washers	B Bolt Nut Washer	Number of bolts, thread. rods C, D	C Threaded rod Nut Washer	D Bolt Washer	T	Bolt size	Number of bolts, thread. rods A, B	A Threaded rod Nut Washers	B Bolt Nut Washer	Number of bolts, thread. rods C, D	C Threaded rod Nut Washer	D Bolt Washer	T
32	11/4	M16	4	110	90 "B"	8	55	35	18	1/2"-13 UNC	4	100	90	8	45	30	16
40	11/2	M16	4	110	90 "B"	8	55	35	18	1/2"-13 UNC	4	100	90	8	45	35	18
50	2	M16	4	120	100 "B"	8	60	40	18	5/8"-11 UNC	4	130	110	8	60	40	20
65	2 1/2	M16	4	130	110 "B"	8	60	40	18	5/8"-11 UNC	4	140	115	8	65	45	22
80	3	M16	8	130	110 "B"	16	60	45	20	5/8"-11 UNC	4	140	120	8	65	45	24
100	4	M16	8	140	120 "B"	16	65	45	20	5/8"-11 UNC	8	150	125	16	70	50	24
125	5	M16	8	150	120 "B"	16	70	50	22	3/4"-10 UNC	8	160	130	16	75	50	24
150	6	M20	8	150	130 "B"	16	75	50	22	3/4"-10 UNC	8	160	140	16	75	55	25
200	8	M20	12	160	140 "B"	24	80	55	24	3/4"-10 UNC	8	175	150	16	80	60	28
250	10	M24	12	180	150 "B"	24	90	60	26	7/8"-9 UNC	12	190	165	24	90	65	30
300	12	M24	12	200	170 "B"	24	95	70	28	7/8"-9 UNC	12	210	180	24	95	70	32
350	14	M24	16	200 "B"	170 "B"	32	100	70	30	1"-8 UNC	12	220	190	24	110	75	35
400	16	M27	16	230 "B"	200 "B"	32	110	85	32	1"-8 UNC	16	240	210	32	120	90	37
450	18	M27	20	240 "B"	220 "B"	40	120	90	34	1 1/8"-7 UNC	16	260	235	32	125	95	40
500	20	M30	20	280 "B"	250 "B"	40	120	90	36	1 1/8"-7 UNC	20	290	255	40	130	95	43
600	24	M33	20	310 "B"	280 "B"	40	140	100	40	1 1/4"-7 UNC	20	330	290	40	140	110	48
700	28	M33	20 "U"	320 "U"	290 "U"				40	1 1/4"-7 UNC	24 U	370 "U"	320 "U"				71
700	28	M33				8 "U"	95 "U"	60 "U"	40	1 1/4"-7 UNC				8 "U"	125 "U"	90 "U"	71
800	32	M36	20 "U"	360 „U	320 "U"				41	1 1/2"-6 UNC	24 U	415 "U"	375 "U"				81
800	32	M36				8 "U"	100 "U"	60 "U"	41	1 1/2"-6 UNC				8 "U"	145 "U"	105 "U"	81
900	36	M36	24 "U"	385 "U"	350 "U"				48	1 1/2"-6 UNC	28 "U"	440 "U"	400 "U"				90
900	36	M36				8 "U"	110 "U"	70 "U"	48	1 1/2"-6 UNC				8 "U"	155 "U"	115 "U"	90
1000	40	M39	24 "U"	430 "U"	380 "U"				59	1 1/2"-6 UNC	32 "U"	455 "U"	415 "U"				90
1000	40	M39				8 "U"	125 "U"	85 "U"	59	1 1/2"-6 UNC				8 "U"	155 "U"	115 "U"	90
1200	48	M45	28 "U"	520 "U"	480 "U"				78	1 1/2"-6 UNC	40 "U"	570 "U"	520 "U"				108
1200	48	M45				8 "U"	155 "U"	110 "U"	78	1 1/2"-6 UNC				8 "U"	180 "U"	140 "U"	108
1400	56	M45	32 "U"	555 "U"	500 "U"				84	1 3/4"- UNC	44 "U"	635 "U"	580 "U"				124
1400	56	M45				8 "U"	165 "U"	120 "U"	84	1 3/4"UNC				8 "U"	205 "U"	160 "U"	124
1600	64	M52	36 "U"	645 "U"	580 "U"				102	1 3/4"UNC	48 "U"						
1600	64	M52				8 "U"	195 "U"	140 "U"	102	1 3/4"UNC				8 "U"			

"U" - applies to U-type valves